

EEDSP

Single Phase Keypad Prepaid kWh meter



1. Summary

EEDSP meter is a modern single phase prepaid energy meter designed according to latest craft and design. Customer purchases energy from the vending software to generate one 20 digits encrypted "TOKEN", then enter into prepayment meter by keypad on the meter. The credit will be entered into the meter after the TOKEN being accepted.

The data transmission protocol of the meter complies with IEC62055-41, All the specifications comply with IEC62055-31. And meter designed in accordance with IEC62053-21.

2. Features and technical parameters

2.1 Features

- Measure active energy (kWh);
- Unidirectional or Bi-directional Measurement;
- 6+2 LCD display with backlight;
- 20-digit transmission as a token, customer purchases energy before consumption;

- Low energy alarm and low energy trip to remind the customer to purchase energy;
- With optical communication port for reading meter data and setting parameters;
- Overload protection;
- Open terminal cover and base cover detection alarm;
- Meter Information supply short code Enquiry;
- Multi-Level alarm value enable setup;

2.2 Technical parameters

Rated current	5(60)A, 5(80)A
Rated voltage	AC 220V, 230V, 240V
Voltage range	± 20%
Frequency	50 / 60Hz
Accuracy	Class 1
Starting current	0.4%Ib
Power consumption	< 4VA, 1.5W
Meter constant	1000imp/kWh
Operation temperature	-10°C ~ +70°C

Notice: Please refer to the nameplate for the real values of rated current, accuracy class and meter constant of a specific meter.

3. Description

3.1 Outline diagram

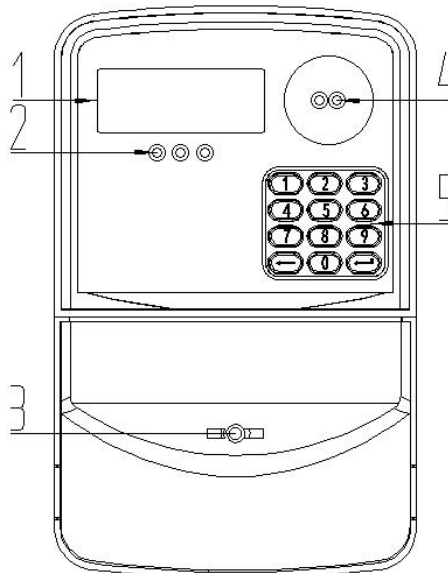

Figure 1

1- LCD display with backlight.

2- LED indicators. From left to right are: Pulse, alarm, status credit.

3- Assistance terminals, and detector of terminal cover opening.

4- Optical communication port

5- Keypad contains 12 buttons (0~9, "←" and "↵") to enter TOKEN and query meter data.

3.2 LCD display screen with back light

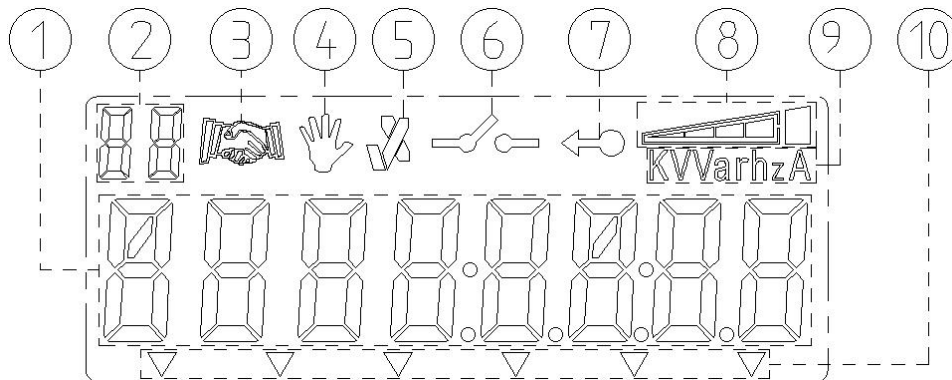

Figure 2

1- Main display area

2- Display item No.(OBIS code)

3- Friendly time

4- Tamp

5- Indication of token acceptance or rejection

6- Relay trip off status

7- Negative Power

8- Credit status

9- Measure unit

10- other indicator

3.3 Pulse: kWh consume indicator

3.4 Alarm:

3.3.1 The cover was opened.

3.3.2 The load is reverse, unbalance, or overload.

3.3.3 The voltage is over voltage, or under voltage.

3.5 Status credit: credit indicator

3.4.1 The green LED indicates the remained credit is enough.

3.4.2 The yellow LED indicates the remaining energy is below remained energy threshold 1.

3.4.3 The red LED indicates the remain credit is below remained credit threshold 2.

3.4.4 When the red LED is flash, it means the remaining credit is below remained credit threshold 3.

3.6 Keypad contains 12 buttons to enter TOKEN and query information

3.7 Optical port complies with IEC62056-21

3.8 Open cover detector inside the terminal

3.9 Operation principle

As shown in figure 3, the current and voltage of power covered into small signal separately and input into a special measurement IC, after a series of process such as multiplication calculation etc. and then output energy pulse, whose frequency is in direct proportion to the supply power, to the microprocessor unit (MCU). The MCU calculate and process energy impulse to perform the power metering and load control functions etc. The LCD displays the total credit and remained credit etc. relay tripping off indirect shows the meter operation state.

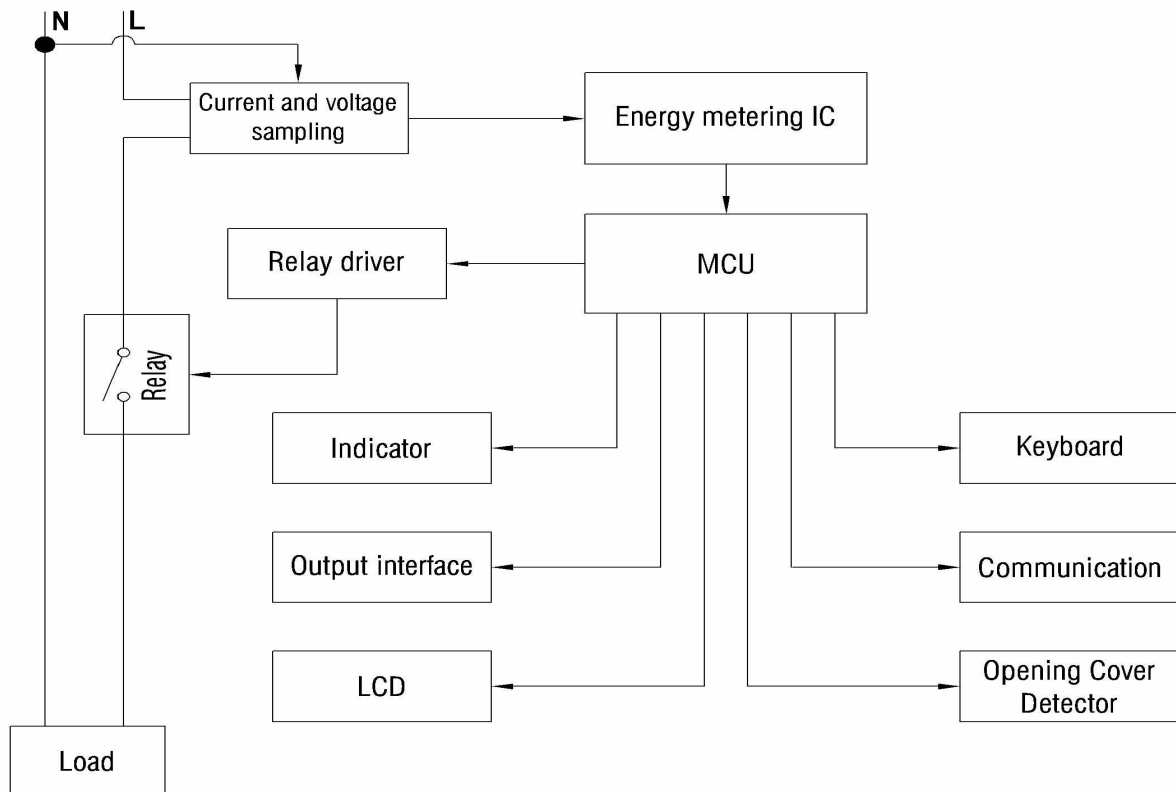

Figure 3

4. Application of TOKEN



4.1 Purchase credit

Customer purchases the credit with Meter factory own vending software.

4.2 Entering TOKEN





Tokens are entered by the keypad on the meter. The meter sounds a “bi” every time a button

pressed and displays the number on the main display area of the LCD. The number entered last displays at the most right-hand side. Per 4 digits appear “-”, When the eighth digit entered, the digit entered first will be moved out of the LCD. Press “⇐” to remove digits, one at a time, from the end of entered numbers.

Figure	Description
	<p>Before pressing “⇐” button.</p>
	<p>After pressing “⇐” button, the last digital “7” is deleted.</p>

4.3 Recharge success

After finish these 20 digits TOKEN, press “↵” key to confirm. If the TOKEN is correct and accepted by meter, it will display “error information” and “✓” indicator on the LCD and sound “bi” long times. New purchased credit will increment the remaining credit register.







Figure	Description
	<p>eleven digits have been inputted, the last one is “9”.</p>
	<p>After all of the TOKEN numbers inputted, Press “↵” to confirm.</p>
	<p>The TOKEN is correct and accepted by the meter. Indicator “✓” means successful.</p>
	<p>The new purchased credit of TOKEN is 50kWh.</p>

4.4 Recharge failure

Meter will sound “bi” three times and give the indicator of “✗” and show “used” or “old” or

“reject” on LCD main display area, failure code will display on lower-left quarter of LCD. Remaining credit will not be changed.

Keypad lock-out function. If type incorrect TOKEN continuously more than 10 times, meter keypad will locked for security consideration. Max lock time is 60 seconds. During keypad locked period, meter will not accept credit TOKEN and clear TOKEN, but the user can use keypad to query meter data. and accept new credit TOKEN after 60 seconds.







Figure	Description
	Meaning: indicates the rejection of a token. Solution: Check the TOKEN with vending station.
	Meaning: TOKEN is old or has expired. Solution: Get another new TOKEN.
	Meaning: TOKEN has been used. Solution: Get another new TOKEN.
	Meaning: Credit TOKEN has been rejected due to a credit overflow condition should the TOKEN be accepted. Solution: use more credit, then try again
	Meaning: TOKEN has been rejected due to the CRC verification is incorrect. Solution: Check the TOKEN with vending station.
	Meaning: TOKEN continuously has been rejected. Solution: After 60seconds, enter TOKEN again.

5. Display function

There are three kinds of display status: Scrolling display, RWP display and Querying display.





5.1 Scrolling display











The meter auto-enter into scrolling display mode after power on. The LCD displays remained credit and total credit with 8 seconds interval. When pressing any key, the backlight will be turned on and last 60 seconds.









Figure	Description
	<p>Remained purchased credit Purchased credit remains 130.65 kWh. Indicator “” means credit level status. 01 - Item No.</p>
	<p>Total used kWh Total consumption kWh is 120.28kWh. Indicator “” appears when meter is the status of friendly time. indicator “” means overdraft credit, the meter built-in relay has been tripped off, power supply has been cut down. 02 - Item No.</p>
	<p>Error information When fault happened, fault indicator display automatically till it is reverted; Error - 01: Relay fault; Error - 02: Over Load Error - 03: Over Voltage Error -05: Under Voltage Error - 06: E2prom fault; Error - 09: Relay testing fault; Error - 10: Open terminal cover (tamper) Error - 11: Open main cover</p>

5.2 Querying display

Customer can press compounding key to query meter information. First, press number key, then press “”. LCD will display the corresponding information.

Short Code	Figure	Description
“0”+“  ”		<p>LCD Self-check Full screen display test</p>
“1”+“  ”		<p>Relay Self-check Relay connection and disconnection test Display Item No. Is 01.</p>

		
“2”+“↵”		Buzzer Self-check Buzzer speak “bi” test. Display Item No. Is 02.
“3”+“↵”		Total used kWh Total consumption kWh is 21.20kWh. Display Item No. Is 03.
“4”+“↵”		KRN and KT display KRN(key revision no.) is 1. KT(key type) is 2. Display Item No. Is 04.
“5”+“↵”		TI display TI(Tariff index) is 1. Display Item No. Is 05.
“6”+“↵”		MFC display MFC(Manufacturer Code) is 325. Display Item No. Is 06.
“7”+“↵”		MPL display MPL(Maximum power limit) is 13.2kW. Display Item No. Is 07.
“8”+“↵”		Tamper words display Bit0 is terminal cover is opened Bit1 is base cover is opened Bit2 is negative power Bit3 is magnetic disturb Bit4 is load unbalance Bi5-Bit7 is reserved Display Item No. Is 08.
“9”+“↵”		Power display Instantaneous Power is 12.5800kW. Display Item No. Is 09.
“10”+“↵”		Software version display Software version is 01.01. Display Item No. Is 10.

“20”+“  ”	Voltage display
“21”+“  ”	Current display
“22”+“  ”	Active Power display
“23”+“  ”	Reactive Power display
“24”+“  ”	Apparent Power
“25”+“  ”	Power Factor
“26”+“  ”	Frequency
“27”+“  ”	Remain Amount

6. Dimension and installation

6.1 Meter should have been initialized and the basic parameters should have been set before installation..

6.2 Meter should have manufacturer sealing.

6.3 Meters should be installed indoors, meter base should be fixed firmly on anti-fire wall without erosion gas around. 1.8 meter height installation is recommended.

6.4 The connection should be carried out according to the diagram printed on the terminal cover and copper cable is ready for connection.

6.5 Connection diagrams

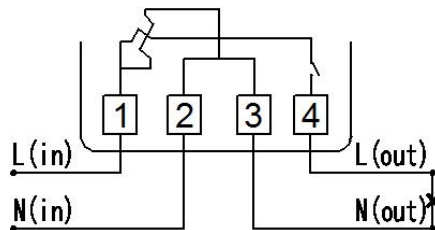

6.6 Overall and mounting dimensions

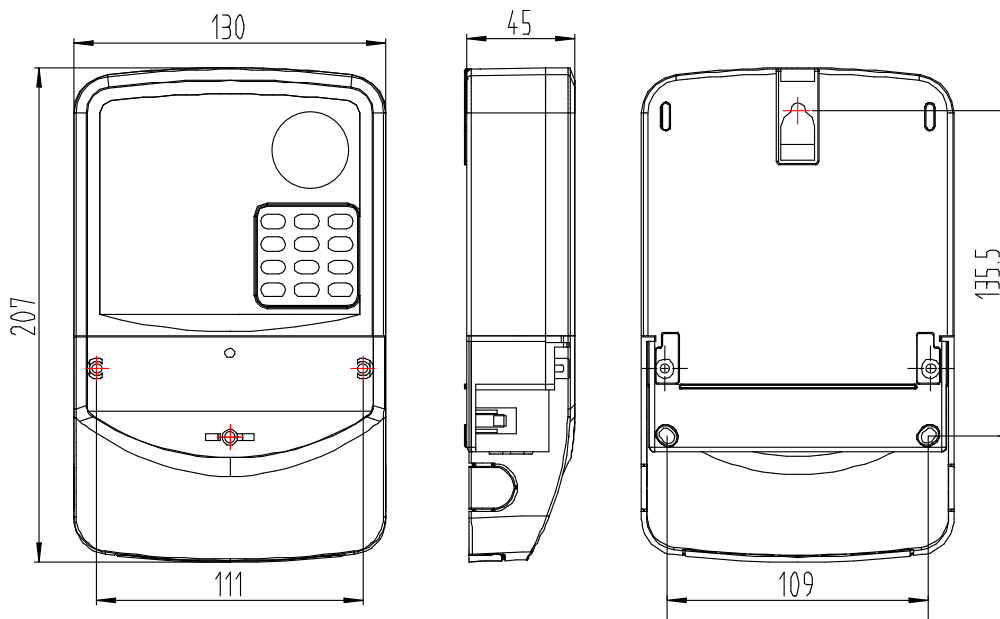

Figure 6